

USER INSTRUCTION MANUAL: WEBBING SELF-RETRACTING LANYARDS

WARNING: *This product is a component of a personal fall arrest or restraint system where falls may occur over edges. The user must understand the manufacturer's instructions and be trained in the proper use of each component or part of the complete personal fall arrest system. Manufacturer's instructions must be followed for proper installation, use, care, and maintenance of this product. These instructions must always be available for reference. Alterations or misuse of this product or failure to follow instructions may result in serious injury or death.*

IMPORTANT: *This manual is intended to meet the Manufacturer's Instructions as required by the American National Standards Institute (ANSI) Z359.14-2014 and should be used as part of an employee training program as required by the Occupational Safety and Health Administration (OSHA). All components or subsystems used with the SRL discussed in this manual must be in compliance with ANSI Z359 and OSHA.*

1.0 WARNINGS REGARDING THE SRL:

- Before use, thoroughly inspect the SRL as indicated in Section 8.
- Immediately pull the SRL from service and label as 'UNUSABLE' if: inspection shows any evidence of damage or malfunction, the unit has been subject to a fall arrest forces, or if the lifeline becomes slack.
- Never extend the lifeline beyond its operational limit.
- Before installation, always identify and eliminate (when possible) hazards from the work area, including those which may damage your fall protection equipment. Examples of hazards include overhead hazards (cranes, power lines, etc.), surface hazards (cables, hoses, etc.), and obstruction hazards (vertical columns, other workers, etc.).
- A clear fall path is necessary in order for the SRL to positively lock. Do not use the SRL in applications that have an obstructed fall path.
- Do not knot the lifeline, allow two SRL's to become entangled with one another during use, or prevent the lifeline from retracting or being taut.
- The worker may not reach sufficient speeds for the SRL to positively lock in applications such as confined spaces, or if work is taking place on slowly shifting material (such as sand or gravel).
- Avoid sudden movements, which may unintentionally activate the braking mechanism.
- Ensure that all components of the complete personal fall arrest system are compatible, and meet requirements outlined in applicable standards such as ANSI Z359. Before using these systems, always consult a Competent Person.
- Always ensure adequate fall clearance before using this equipment.
- Do not allow the lifeline to remain outside the housing when not in use.
- Always minimize swing falls by working as close to the anchorage point as possible.

2.0 WARNINGS REGARDING WORKING AT HEIGHT:

- Before use, consult your doctor to ensure that your physical condition allows you to safely withstand the impact of all forces involved with working at height.
- Do not use any fall protection equipment that has failed inspection.
- Ensure all connections are compatible, and that all subsystem combinations do not interfere with the function of this SRL.
- Ensure that a written rescue plan, and the means to implement it, are always available when using this equipment. For more information, refer to ANSI Z359.4-2013 and Z359.2-2017.
- Immediately seek medical attention for the affected party if a fall event occurs.
- When inspecting, installing, or using the device / system, always ensure that you wear appropriate Personal Protective Equipment.
- Never exceed maximum free fall distance and allowable capacity for your fall protection as labeled.
- Never expose workers to fall hazards during training.

3.0 DESCRIPTION:

3.1 KEY COMPONENTS: Refer to Figure 1 for identification of key components of Self-Retracting Lanyards. Bashlin SRL's are drum wound Webbing Lifelines (A) that retract into a Nylon or Aluminum Housing (B). The Swivel Eye (D) on top of the SRL allows units to hang from anchorage by an attached Carabiner (C). The SRL is attached to the Fall Arrest connection on a Full Body Harness via a self-locking snap hook (E) on the end of the Lifeline.

3.2 TYPE OF SRL: Refer to Appendix A for unit specifications. SRL's include:

- **SELF RETRACTING LANYARDS:** Are suitable for overhead anchorage (i.e.: from directly above the user's head to as low as the dorsal D-ring on the user's FBH), where the lifeline remains generally vertical during use, and where no free fall is possible. An external shock pack is integral to the webbing lifeline between the housing and self-locking snap hook.

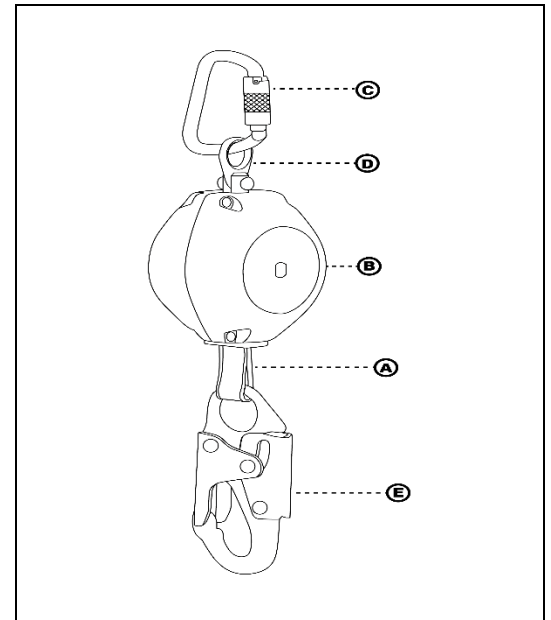

Figure 1: Key components of webbing SRL

4.0 APPLICATIONS:

4.1 PURPOSE: Self-Retracting Devices are components of a complete personal fall arrest system designed for use in applications where workers require mobility at heights (i.e.: construction work, oil production, etc.). **Do not intentionally misuse or alter this equipment.**

4.2 COMPLIANCE: When installed properly, the SRL meets ANSI Z359.14-2014 requirements for Self-Retracting Devices and OSHA 1910.140/1926.502 regulations. NOTE: For more information consult the ANSI Z359 body of standards.

Arc Flash compliant SRLs have been exposed to an electrical arc following ASTM F887 test procedures and subsequently tested to ANSI Z359.14 qualification testing procedures for SRLs.

SRLs that have been tested in accordance with OSHA 1910.140/1926.502 for users over 310 lbs were not exposed to arc flash prior to testing.

4.3 TRAINING: Installation of this equipment must be performed by persons with training in its correct application and use. The user bears full responsibility for understanding the contents of these instructions and assuring they are trained in the correct care and use of this equipment, such as the operating characteristics, application limits, and consequences of improper use. During training, the user must not be subjected to a fall hazard.

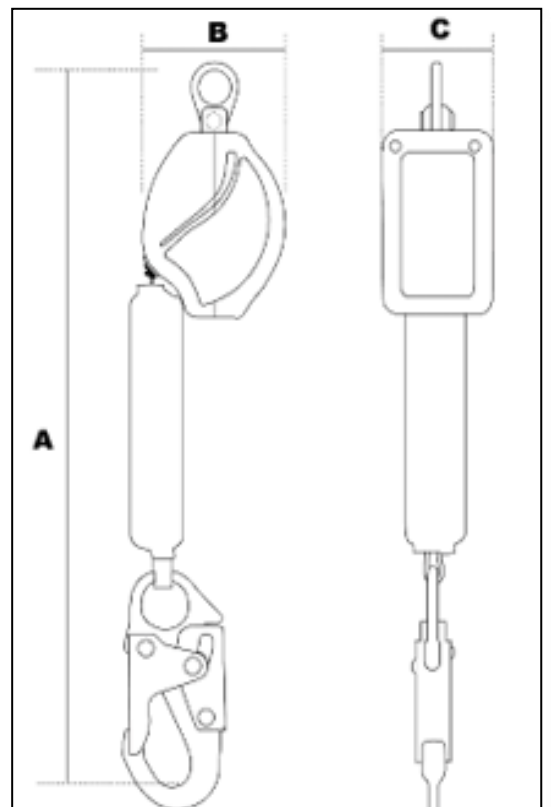

Figure 2: Webbing SRL with external shock pack

IMPORTANT: Immediately remove equipment from service if it has been subject to a fall arrest forces OR has failed inspection (see Section 8 for inspection procedures).

5.0 LIMITATIONS:

5.1 WEIGHT CAPACITY: As per ANSI, the SRL is designed for use by persons with a total weight (includes clothing, tools, etc.) between 130 lbs (58.97 kgs) and no more than 310 lbs (140.61 kgs). Pregnant people and minors are not to use this equipment. Workers over 310 lbs must not use these SRL's where falls over edges may occur. Failure to comply may result in equipment malfunction, serious injury, or death.

Per OSHA 1910.140/1926.502, SRLs with a 420 lb capacity are designed for use by persons with a total weight (including clothes, tools, etc.) up to 420 lbs. Workers over 420 lbs must not use these SRL's where falls over edges may occur. Failure to comply may result in equipment malfunction, serious injury, or death.

Weight capacity for arc flash compliant SRLs - arc flash compliant SRLs have been exposed to an electrical arc following ASTM F887 test procedures and subsequently tested to ANSI Z359.14 qualification testing procedures for SRLs for 310 lbs users. SRLs are not arc flash tested for users over 310 lbs.

5.2 ANCHORAGE: The anchorages selected for fall arrest systems shall have a strength capable of sustaining static loads applied in the directions permitted by the system of at least: 5,000 lbs (22.2 kN) for non-certified anchorages, OR two times the maximum arresting force for certified anchorages. When more than one fall arrest system is attached to an anchorage, the strengths set forth in (1) and (2) above shall be multiplied by the number of systems attached to the anchorage. According to OSHA 1926.500 and 1910.66, anchorages used for attachment of personal fall arrest systems shall be independent of any anchorage being used to support or suspend platforms, and capable of supporting at least 5,000 lbs (22.2 kN) per user attached, or be designed, installed, and used as part of a complete personal fall arrest systems which maintains a safety factor of at least two, and is under the supervision of a qualified person.

5.3 FREE FALL: To reduce fall distance, always attempt to anchor the SRL directly overhead. Overhead anchoring will limit free fall distance to a minimum length. Be aware of workers sharing the workspace to avoid becoming tangled with another worker. Steer clear of objects that could fall and impact the lifeline. The lifeline should never pass under the user's arms or legs. The lifeline should never be knotted, clamped, or be otherwise restricted from retraction or a taut state.

5.4 CALCULATING MINIMUM REQUIRED FALL CLEARANCE: Refer to diagrams and calculation chart in Appendix B and C. Figure 1B and Figure 2B illustrate fall clearance – when the SRL is directly overhead (Figure 1B) and in swing fall situations (Figure 2B). Swing fall situations require additional fall clearance since the total vertical fall distance is greater than if the user had fallen directly below the SRL. Figure 1C, Table 1C illustrates minimum required fall clearance calculation for falls from a standing position where the SRL is anchored overhead. Falls from a kneeling position require an additional 1m (3 ft) of fall clearance.

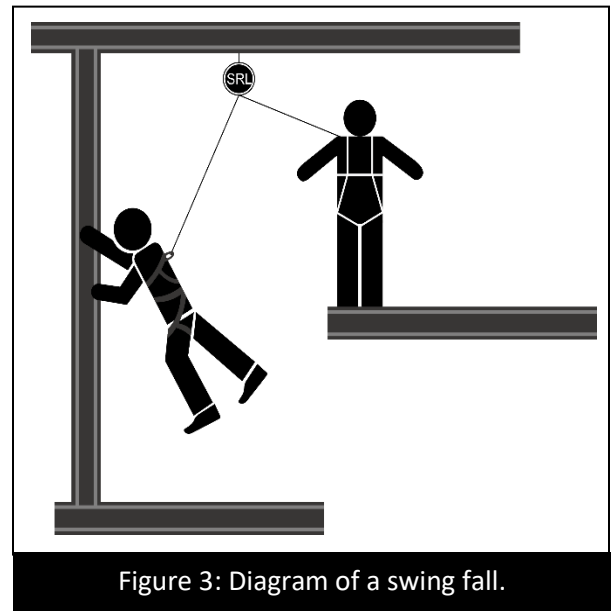

5.5 SWING FALLS: Swing falls occur when the anchorage point is not positioned directly above the point at which a fall occurs (refer to Figure 3). The resultant force of striking an object while in a swing fall may cause serious injury or death. Do not permit a swing fall if injury could occur. To minimize swing falls, work as close to the anchorage point as possible.

5.6 SHARP EDGES: Avoid using the SRL on sharp edges, metals cut with abrasive disks, or flame cut metals. Use caution when working with abrasive surfaces / edges, such as those present on concrete and stone, which may grind the lifeline / shock absorber during a fall. In leading edge applications, only use Leading Edge SRL's.

5.7 LOCKING SPEED: The nature of this equipment requires sufficient space in the working area to allow for the SRL to lock. Working in small or confined spaces may keep the user's body from reaching the speed needed to lock the SRL during a fall. Working on slowly shifting materials, such as grain or sand, may not allow the speed needed to cause the SRL to lock.

- 5.8 HAZARDOUS ENVIRONMENTS:** Additional precautions to prevent injury to the user or damage to the equipment may be required if this equipment is used in hazardous environments. Hazards may include high heat, severe cold, chemicals, voltage power lines, moving machinery, and sharp edges, among other things. Contact the manufacturer if there are any doubts about the suitability of an environment.
- 5.9 RESCUE PLAN:** Ensure that a written rescue plan, and the means to implement it, are always available when using this equipment. For more information, refer to ANSI Z359.4-2013 and Z359.2-2017.
- 5.10 INSPECTION FREQUENCY:** Units must be inspected by a competent person at regular intervals as required by the type of use and working environment (see Table 1). The competent person must use inspection criteria in Table 2. As long as the SRL passes inspection criteria, it may remain in service. If any inspection reveals an unsafe or defective condition, remove the SRL from service immediately and discard. See section 8.0 for further inspection information.

Table 1 - ANSI Z359.14-2014 SRL Inspection Frequency Recommendations			
Type of Use	Application Examples	Conditions of Use	Inspection Frequency (by a Competent Person)
Infrequent to Light	Confined Space, Factory Maintenance	Good storage conditions, indoor / infrequent outdoor use, room temperature, clean environment	Annually
Moderate to Heavy	Transportation, Residential Construction, Utilities, Warehouse	Fair storage conditions, indoor / extended outdoor use, all temperatures, clean or dusty environment	Semi-annually to Annually
Severe to Continuous	Commercial Construction, Oil and Gas, Mining	Harsh storage conditions, prolonged or continuous outdoor use, all temperatures, dirty environment	Quarterly to Semi-annually

6.0 INSTALLATION:

- 6.1 PLANNING:** Before use, ensure that you plan your fall protection system considers all limitations and factors that may affect your safety before, during, and after a fall as outlined in this instruction manual.
- 6.2 ANCHORAGE:** Connect the SRL to anchorage points via the provided carabiner (attached to the swivel eye on the SRL). Refer to Figure 4 for examples of typical anchorages and connections. Anchorages selected should be capable of sustaining static loads indicated in Section 5.2. To minimize swing fall hazards, the anchorage should be directly overhead. If overhead anchorage is not feasible, the SRL may be attached to anchorage points below the user's full body harness dorsal D-ring. **Never use anchorages situated below the user's feet.**
- 6.3 HARNESS CONNECTION:** Users should always use a Full Body Harness in fall arrest applications. Generally, the self-locking snap hook on to the SRL is attached to the dorsal D-ring on the full body harness. Before proceeding, make sure that the snap hook is fully closed and locked. For additional details concerning harness connection points, consult the harness manufacturer's instruction manual.
- 6.4 COMPATIBILITY OF COMPONENTS:** Use the SRL with approved components and subsystems only. Using the SRL with non-approved components and subsystems may interfere with the safety and reliability of the complete system.
- 6.5 COMPATIBILITY OF CONNECTORS:** Connectors (hooks, carabiners, and D-rings) and connecting elements are compatible when their sizes and shapes do not cause gate mechanisms to unintentionally open. Connectors must be capable of supporting at least 5,000 lbs. (22 kN). Connectors must be compatible with the anchorage or other system components to ensure roll-out does not occur. Connectors must be compatible in size, shape, and strength with the connecting elements. Self-locking snap hooks and carabiners are required by ANSI Z359.12, CSA Z259.12, and OSHA. Follow manufacturer's instructions for all system components.

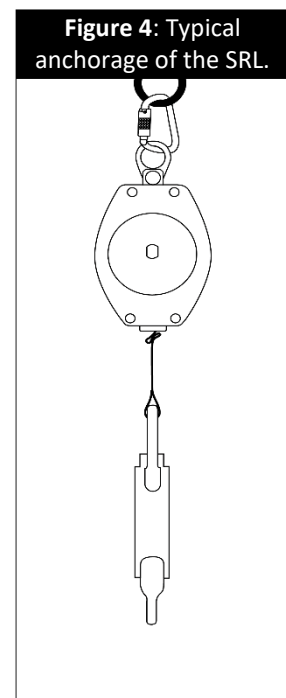

IMPORTANT: Do not use rebar hooks, large carabiners, or large snap hooks to connect to FBH dorsal D-rings or any other non-compatible anchor point as this may cause the connector to unintentionally disengage. Do not insert extra connectors between the SRL lifeline connector and the FBH dorsal D-ring, except an approved D-ring extender.

7.0 OPERATION:

- 7.1 BEFORE USE:** Thoroughly inspect the SRL as indicated in Section 8. If inspection shows any evidence of damage or malfunction, mark the device as 'UNUSABLE' and do not use. Follow all instructions contained within this manual and on the SRL labels. Failure to follow instructions may result in serious injury or death. Ensure all connections are compatible. Implement a written rescue plan and make it readily available to all users. Ensure all users are trained in rescue procedures.
- 7.2 NORMAL OPERATION:** Attach the SRL to suitable anchorages or anchorage connectors (as described in Section 5.2). Generally, the self-locking snap hook on to the SRL is attached to the dorsal D-ring on the full body harness. Before proceeding, make sure that the snap hook is fully closed and locked. For additional details concerning harness connection points, consult the harness manufacturer's instruction manual. Once connected, the worker is permitted to move about the work area, with the lifeline extending and retracting along the working length as applicable. Avoid sudden movements, which may unintentionally activate the braking mechanism. Do not allow the lifeline to become slack – if it does, immediately remove the SRL from service for inspection (as in Section 7).
- 7.3 DURING A FALL EVENT:** If a fall occurs, the braking mechanism will engage, and the lifeline will stop paying out.
- 7.4 AFTER A FALL:** Remove the unit that was subject to fall arrest forces, and store it separate from other units.
- 7.5 MAKING CONNECTIONS:** Equipment (including snap hooks and carabiners) used with the SRL must be self-locking and compatible in size, shape, strength. Do not use equipment that is not compatible. Before use, ensure all connectors are fully closed and locked. Refer to Figure 5. Do not connect snap hooks and carabiners:

- To a D-ring that has another connector attached.
- In a way that results in a load on the gate. If the snap hook does **not** have a 3,600 lb (16kN) gate, it should not be connected to standard size D-rings or other connectors that may result in a load on the gate if the connector rotates.
- In a false engagement where the connectors are not compatible but seem fully engaged.
- To each other.
- Directly to webbing or rope lanyard or tie-back (unless the manufacturer's instructions for both the lanyard and connector specifically allows such a connection).
- To any object whose shape does not allow the snap hook or carabiner to fully close and lock, or would permit roll-out to occur.
- In a manner that does not allow the connector to align properly while under load.

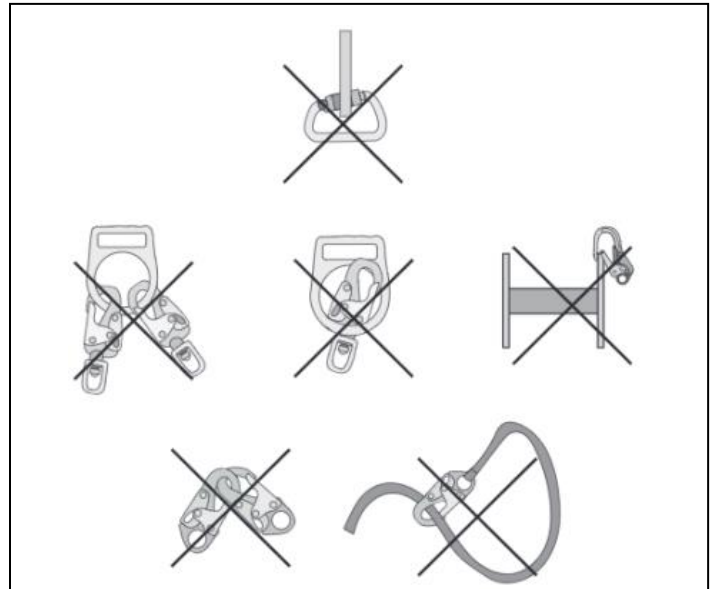

Figure 5: Improper connections

- 7.6 WARNINGS: Do not** engage in the following while using this device:
- **DO NOT** allow any lifeline to pass under arms or between legs.
 - **DO NOT** lengthen the SRL by connecting a lifeline or similar component.
 - **DO NOT** allow the lifeline to freewheel back into the housing. Use a tag line to maintain tension and rewind the lifeline during periods of inactivity. Use the tag line to retrieve the leg end connector for the next use.
 - **DO NOT** leave the tag line connected to the leg end connector when using the SRL for fall protection.

8.0 INSPECTION

8.1 PRE-USE: Before each use, ensure each unit is in good working condition through inspecting as per instructions indicated in Table 2 below. Record results of inspection using the Inspection Record in Appendix E. Remove the unit from service if the unit exhibits damage, defects, inadequate maintenance, activated fall indicators, or any other unsatisfactory results during inspection.

Table 2 - Guidelines for Webbing SRL Inspection		
Inspection	Pass	Fail
The lifeline extracts and retracts without faltering and remains taut under tension.		
Extract the lifeline several inches and apply a firm pull to confirm the SRL locks without skidding. Repeat this at additional places along the lifeline length to confirm the SRL is operating correctly.		
Inspect the entire working length. Examine the lifeline for signs of damage (see Figure 7). Also examine for other debris.		
Ensure that the fall indicator in the shock pack has not been deployed. REMOVE FROM SERVICE IF SHOCK INDICATOR IS DEPLOYED		
Check for any missing or loose screws or nuts and any deformed or damaged components.		
Examine the external housing for signs of damage such as cracks, breaks or warping.		
Check the external Connector Eye and the Anchorage Carabiner for damage and deformation. The Anchorage Carabiner Gate should open and snap shut easily and smoothly.		
Examine the overall SRL unit for any indications of deterioration or damage.		
All labels must be intact and totally legible (see Appendix D).		

8.2 INSPECTION FREQUENCY: Units must be inspected by a competent person at regular intervals, as required by the type of use and working environment. The competent person must use inspection criteria indicated in Table 2. To determine inspection frequency, use Table 1 (Section 5.10). Inspection by a factory authorized inspection agency at regular intervals is also required. As long as the SRL passes inspection criteria, it may remain in service. If any inspection reveals an unsafe or defective condition, remove the SRL from service immediately and discard. See section 8.0 for further inspection information.

8.3 WEBBING DAMAGE Examples of webbing damage are shown in Figure 7. Inspectors must be trained to identify all varieties of damage, not limited to the examples shown in Figure 7. Remove SRL from service if it displays evidence of an unsafe or defective condition. If the SRL has been exposed to an arc flash, remove from service.

8.4 PRODUCT LIFE: The lifespan of SRL's covered by this instruction manual is a function of work conditions, care, and inspection provided. As long as the SRL passes inspection, it may remain in service.

8.5 DISPOSAL: If the SRL has been subject to fall arrest forces or inspection reveals an unreparable defective condition, [harmonize with pg. 1 bullet 2] immediately pull the SRL from service and label as 'UNUSABLE'. If the unit should be disposed of cut the lifeline in half to ensure it is not mistakenly reused.



Figure 7: Examples of webbing damage

9.0 STORAGE, SERVICE, AND MAINTENANCE

- 9.1 MAINTENANCE AND CLEANING:** Ensure that the SRL is kept clean and free of debris that may interfere with the function of the webbing and/or retraction mechanism (i.e.: grease, paint, dirt, etc.). Clean the exterior housing and labels as required using a detergent / water solution. Ensure no debris, water, and other corrosive elements are permitted to enter the housing via the webbing access port. After cleaning, completely pull out the lifeline and allow it to air dry. After the unit is completely dry, retract the lifeline into the unit – taking care not to allow it to freewheel back into the unit. Do not use heat to dry the SRL. Do not try to disassemble the SRL.
- 9.2 STORAGE:** When not in use, store the SRL in a clean, dry, and cool environment out of direct sunlight. Position the unit in such a way that excess water is allowed to drain out. Avoid exposing the SRL to chemical or caustic vapors. After a prolonged period of storage, thoroughly inspect the SRL.
- 9.3 SERVICE:** The SRL is not user repairable. If the SRL does not pass pre-use inspection, tag as “UNUSABLE” and either (a) dispose of it, or (b) contact an authorized service center of Bashlin.

APPENDIX A: UNIT SPECIFICATIONS

Table 1A: Unit Specifications

Part Number	Type	Working Length	A	B	C	Class	Hardware	Max Free Fall	Capacity
BN 9327-6HL	Arc flash SRL	6 ft / 2M	23.4 in / 595 mm	3.0 in / 75 mm	2.4 in / 60 mm	A	Steel	6 ft / 2M	*130-310 lbs / 59-141 kg
BN 9327-6AL	Arc flash SRL	6 ft / 2M	23.4 in / 595 mm	3.0 in / 75 mm	2.4 in / 60 mm	A	Aluminum	6 ft / 2M	*130-310 lbs / 59-141 kg

* Unit capacity is 420 lbs/190 kg per OSHA 1910.140/1926.502

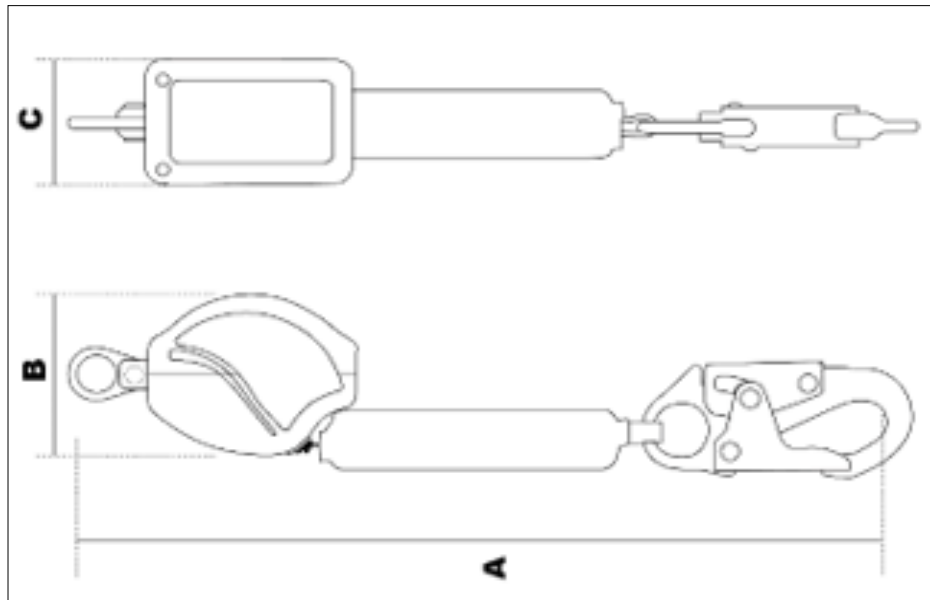

Table 1B: SRL unit classes, as per Section 4.2.1 of ANSI Z359.14

	Class A	Class B
Average Arresting Force	≤ 1,350lbs (6kN)	≤ 900lbs (4kN)
Maximum Arresting Force	≤ 1,800lbs (8kN)	≤ 1,800lbs (8kN)
Maximum Arrest Distance	24 in (0.61M)	54 in (1.37M)

Table 1C: SRL Component Materials

Component	Material
Housing	Thermoplastic
Drum	Aluminum or Thermoplastic
Fasteners	Zinc plated or stainless steel
Locking Pawls	Brass
Main shaft	Stainless steel
Motor Spring	Carbon steel
Swivel	Zinc plated steel
Webbing	0.75 in * 0.075 in (19 mm * 2 mm) Kevlar
Snap hook/ Rebar hook	Forged steel or Aluminum

APPENDIX B: FALL CLEARANCE DIAGRAMS

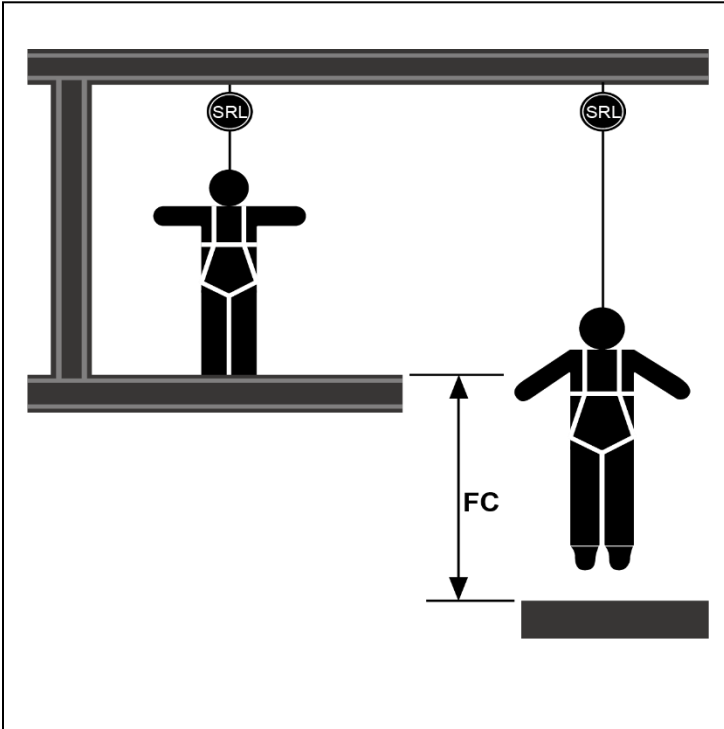

Figure 1B: Fall clearance from a standing position where the SRL is anchored overhead.

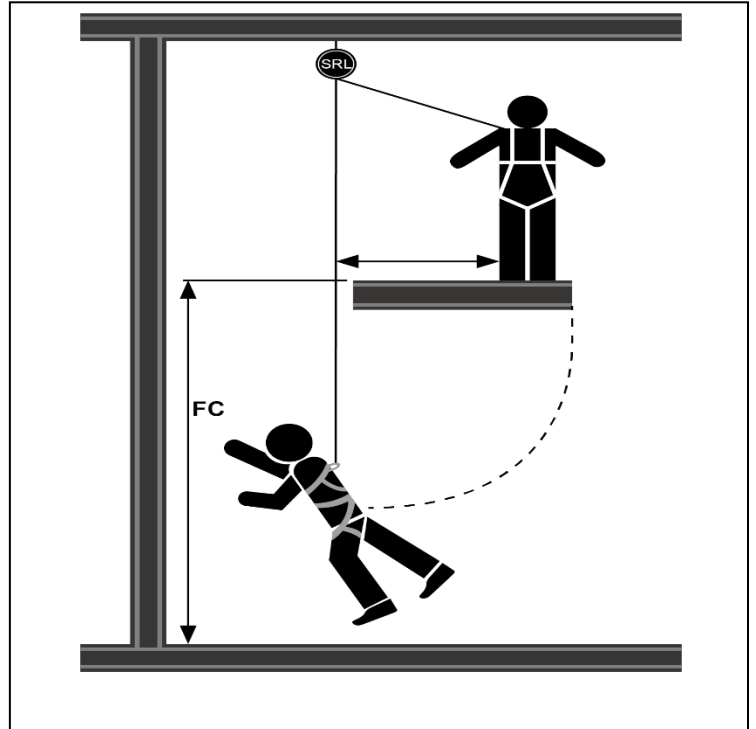

Figure 2B: Fall clearance in swing fall situations.

APPENDIX C: CALCULATING MINIMUM REQUIRED FALL CLEARANCE

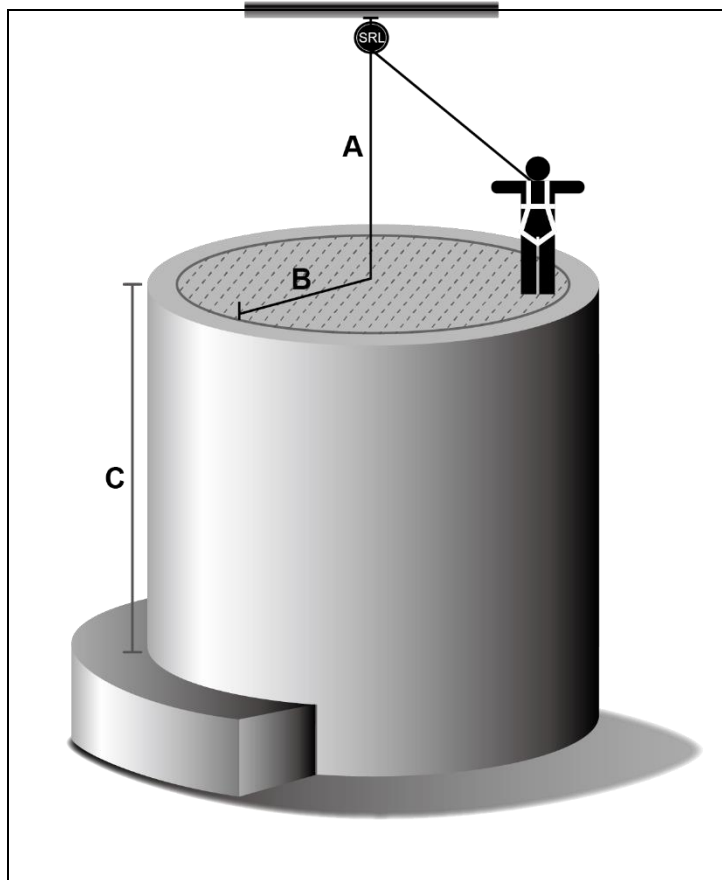

Figure 1C: Minimum required fall clearance for falls from a standing position where the SRL is anchored overhead.

Table 1C: Minimum Required Fall Clearance for falls from a standing position where the SRL is anchored overhead (Class A Unit)							
For Overhead Use *SRL 130-310lbs		B Maximum Work Radius (ft)					
		0	2	4	6	8	10
A SRL Anchor Height (ft)	6	7.0	8.2	10.1	12.1	X	X
	7	7.0	7.8	9.5	11.3	X	X
	8	7.0	7.6	9.0	10.7	12.5	X
	9	7.0	7.5	8.7	10.2	11.9	X
	10	7.0	7.4	8.4	9.8	11.4	X
	12	7.0	7.3	8.1	9.2	10.6	12.2
	14	7.0	7.2	7.8	8.8	10.0	11.5
	16	7.0	7.2	7.7	8.5	9.6	10.9
	18	7.0	7.2	7.6	8.3	9.3	10.4
	20	7.0	7.1	7.5	8.2	9.0	10.0
C Clearance Required							

APPENDIX D: LABELS

All labels must be intact and totally legible prior to SRL use. **DO NOT REMOVE LABELS.**

Figure 1D: Label location

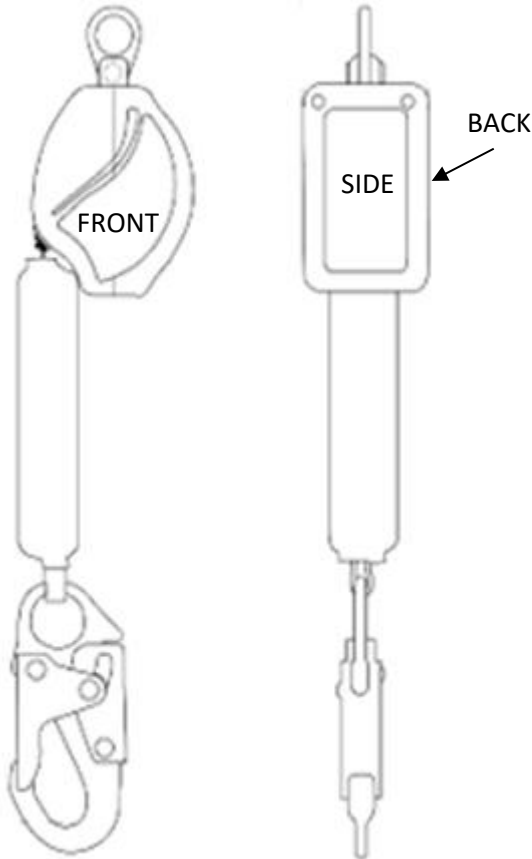

Figure 2D: Side Label

BASHLIN INDUSTRIES INC
DO NOT REMOVE LABELS

Manufacturer's instructions must be read and understood by the user prior to placing this product into service. Failure to do so may result in serious injury or death. The equipment is to be used by properly trained professional workers and should be inspected prior to each use by the user and annually by a competent person, other than the user. The unit shall be removed from service if the fall indicator located in the shock pack is deployed. Always test the locking and retraction of this device before each use. Refer to instructions for inspection procedure. Anchorage and mounting hardware must be capable of supporting 5000 lbs static load or meet OSHA requirements for a safety factor of two to one. See instructions for mounting procedure. Only use by one person as a fall arrestor. Anchor device directly overhead whenever possible. Allow for proper fall clearance below work surface. Do not allow lifeline to come into contact with anything that will damage it including but not limited to sharp, abrasive, rough or high temperature surfaces, moving machinery, electrical hazards, excessive heat or chemicals. See instructions for suitability with horizontal use and compatibility with horizontal lifelines.

WARNING: Device is not to be used after arc

INSPECTION LOG

Figure 3D: Front Label

BASHLIN INDUSTRIES INC
 119 W. Pine Street Grove City, PA 16127

www.bashlin.com
 bashlin@bashlin.com
 724.458.8340

Figure 4D: Back Label

BASHLIN INDUSTRIES INC

P/N: BN 9327-6HL

Working Length: 6'
 Free Fall Limit: 6'
 Avg. Arrest Force: 1350lbs.
 SRD : ANSI Z359.14
 Capacity (ANSI): 130lbs.-310lbs.
 Class: A
 Web: 3/4" Kevlar

Capacity (OSHA 1910.140 only): 420lbs.

SELF RETRACTING LANYARD

SRL

